

M12 Power L-coded 5pol. male 0° / female 0°

PUR 5x1.5 bk UL/CSA+drag chain 2m

Male straight – female straight

M12 – M12, 5-pole

L-coded

Plastic housings with good resistance against chemicals and oils.

The resistance to aggressive media should be individually tested for your application. Further details on request.

Further cable lengths on request.

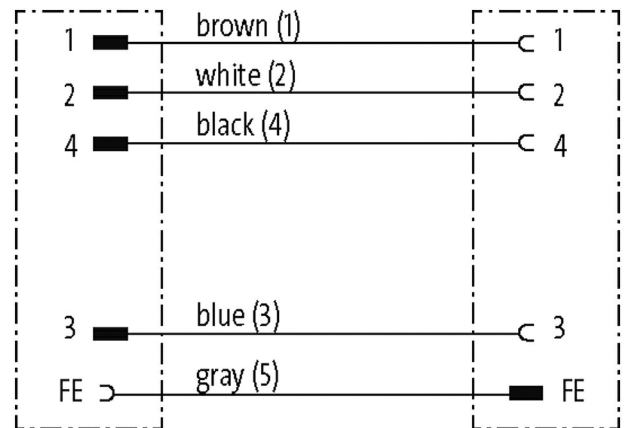
Link to Product**Illustration**

Product may differ from Image

Form

Form P4241

General data

Standards	IEC 61076-2-111
Pollution Degree	3
Temperature range	-25...+85 °C, depending on cable quality
Material (gasket)	FKM

Cables

No./diameter of wires	5 × 1.5 mm ²
Wire isolation	PP (br, wh, bl, bk, gr, num)
C-track properties	5 Mio.
Jacket Color	black
Material (jacket)	PUR (UL/CSA)
Outer Ø	8.7 mm ±5%
Bend radius (moving)	10 × outer Ø
Temperature range (fixed)	-50...+80 °C
Temperature range (mobile)	-20...+80 °C
Cable identification	P04

Cable Type	3 (PUR)
Approval (cable)	cURus (AWM-Style 21223/10492)
Cable weight [g/m]	129,80
Material (wire)	Cu wire, bare
Resistor (core)	max. 13.3 Ω /km (20 °C)
Single wire \varnothing (core)	0.15 mm
Construction (core)	84× 0.15 mm (multi-strand wire class 6)
Diameter (core)	5× 1.5 mm ²
AWG	similar to AWG 16
Material (wire isolation)	PP
Material property (wire isolation)	CFC-, halogen-, cadmium-, silicone- and lead-free
Shore hardness (wire isolation)	60 ±5 D
Wire- \varnothing incl. isolation	2.3 mm ±5%
Color/numbering of wires	bk, bl, wh, br, gr, num
Stranding combination	5 wires twisted around central filler
Shield	no
Material (jacket)	PUR
Material property (jacket)	CFC-, halogen-, cadmium-, silicone- and lead-free, matt, low-adhesion, machine easy to process, abrasion-resistant, hydrolysis and microbial resistant
Shore hardness (jacket)	90 ±5 A
Outer- \varnothing (jacket)	8.7 mm ±5%
Color (jacket)	black
chemical resistance	good resistance to oil, gasoline and chemicals (EN 60811-404)
thermal resistance	flame retardant UL 1581 VW1 / CSA FT1 / IEC 60332-1, IEC 60332-2-2
Nominal voltage	1000 V AC
Test voltage	10.0 kV
Current load capacity	to DIN VDE 0298-4
Temperature range (fixed)	-50...+80 °C
Temperature range (mobile)	-20...+80 °C
Bend radius (fixed)	7.5× outer \varnothing
Bend radius (moving)	10× outer \varnothing
No. of bending cycles (C-track)	max. 5 Mio. (25 °C)
Traversing distance (C-track)	max. 5 m (horizontal)
Travel speed (C-track)	max. 3.3 m/s
Acceleration (C-track)	max. 5 m/s ²
Torsion stress	±180°/m
No. of torsion cycles	max. 2 Mio. (25 °C)
Torsion speed	35 cycles/min
Technical Data	
Operating voltage	max. 63 V AC/DC
Rated surge voltage	1.5 kV
Operating current per contact	max. 16 A
Material group	IEC 60664-1, category I
Coding	L-coded
Locking of ports	Screw thread (M12×1 mm) recommended torque 0.6 Nm, self-securing
Compression gland	M12 (SW17)
Protection	IP65 and IP67 when plugged and screwed down (EN 60529)
Locking material	Zinc die casting, matte nickel plated
Material	PUR

suitable for corrugated tube (internal Ø) 12 mm

Commercial data

country of origin	DE
customs tariff number	85444290
EAN	4048879705196
eClass	27279218
Packaging unit	1

Sketch

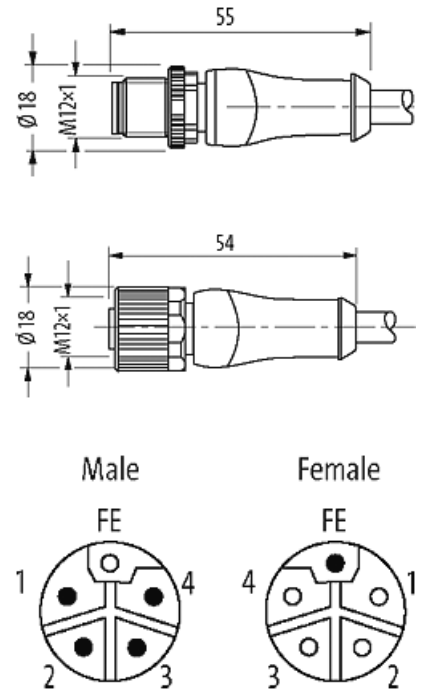

Product may differ from Image